

## GNS-5213Ax-Bx (SINGLE DIGIT LED DISPLAY)

### GNS-5213 Series

### GNS-5213Ax

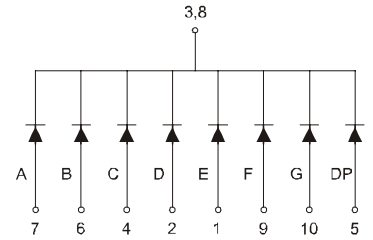
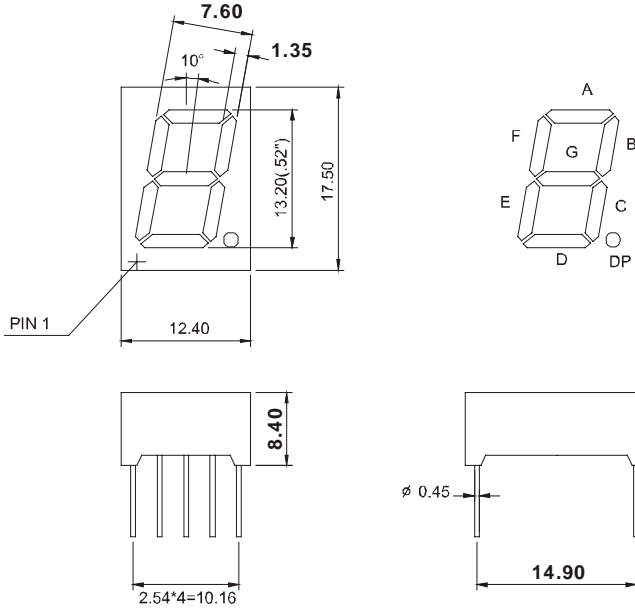

### GNS-5213Bx

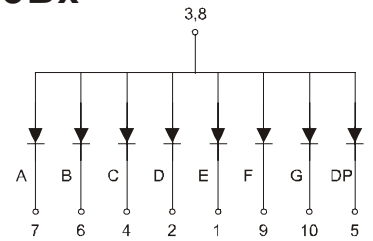

### Features:

\*0.52 INCH HIGH CHARACTER.

\*EXCELLENT CHARACTER APPEARANCE.

\*COMMON CATHODE OR COMMON ANODE.

\*I.C. COMPATIBLE.

\*LOW POWER CONSUMPTION.

Part Number	EMITTED COLOR		Common Cathode or Common Anode	Peak Wavelength (nm)	Vf (v) Typ	If (mA)	Intensity Per Segment (mcd)	
							Min.	Typ.
GNS-5213AE	GaAsP/GaP	Hi.effi Red	Common Cathode	635	2.0	20	9	12
GNS-5213AG	GaP	Green		565	2.1	20	8	11
GNS-5213AY	GaAsP/GaP	Yellow		585	2.0	20	9	12
GNS-5213AS	GaAlAs	Super Red		660	1.8	20	10	13
GNS-5213AD	GaAlAs	Ultra Red		660	1.8	20	25	30
GNS-5213AUE	AlGaInP	Ultra Red		625	2.0	20	30	35
GNS-5213AUY	AlGaInP	Ultra Yellow		590	2.0	20	30	35
GNS-5213BE	GaAsP/GaP	Hi.effi Red	Common Anode	635	2.0	20	9	12
GNS-5213BG	GaP	Green		565	2.1	20	8	11
GNS-5213BY	GaAsP/GaP	Yellow		585	2.0	20	9	12
GNS-5213BS	GaAlAs	Super Red		660	1.8	20	10	13
GNS-5213BD	GaAlAs	Ultra Red		660	1.8	20	25	30
GNS-5213BUE	AlGaInP	Ultra Red		625	2.0	20	30	35
GNS-5213BUY	AlGaInP	Ultra Yellow		590	2.0	20	30	35